

\_AKTIONSZEITRAUM: 17.01. – 04.03.2022

**Ideal für unterschiedliche Werkstoffe.**

**Sparen Sie jetzt!**

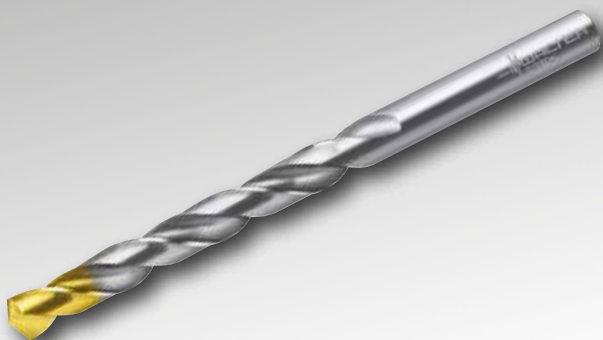

Ihr  
Preisvorteil

**60%**



Ihr  
Preisvorteil

**20%**



## Ihre Vorteile:

- Flexibilität durch breiten Einsatzbereich bei verschiedenen Werkstoffen
- Hohe Prozesssicherheit



Ihr  
Preisvorteil  
**60%**

# HSS-Spiralbohrer DA110 Perform

Jetzt bestellen zum attraktiven Aktionspreis!



- Typ N

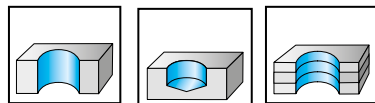

P	M	K	N	S	H	O
●●	●	●●	●			●

WZ90AJ

Bezeichnung	Ø metrisch	Brutto- preis	Aktions- preis*	Stück
DA110-08-01.000U0-BOW-1	1	3,31 €	1,32 €	
DA110-08-01.200U0-BOW-1	1,2	3,75 €	1,50 €	
DA110-08-01.500U0-BOW-1	1,5	2,68 €	1,07 €	
DA110-08-02.000U0-BOW-1	2	2,01 €	0,8 €	
DA110-08-02.500U0-BOW-1	2,5	2,41 €	0,96 €	
DA110-08-03.000U0-BOW-1	3	1,99 €	0,80 €	
DA110-08-03.200U0-BOW-1	3,2	2,66 €	1,06 €	
DA110-08-03.300U0-BOW-1	3,3	2,66 €	1,06 €	
DA110-08-03.500U0-BOW-1	3,5	2,40 €	0,96 €	
DA110-08-04.000U0-BOW-1	4	2,35 €	0,94 €	
DA110-08-04.200U0-BOW-1	4,2	3,22 €	1,29 €	
DA110-08-04.400U0-BOW-1	4,4	3,92 €	1,57 €	
DA110-08-04.500U0-BOW-1	4,5	3,40 €	1,36 €	
DA110-08-05.000U0-BOW-1	5	2,99 €	1,20 €	
DA110-08-05.200U0-BOW-1	5,2	4,32 €	1,73 €	
DA110-08-05.500U0-BOW-1	5,5	4,20 €	1,68 €	
DA110-08-06.000U0-BOW-1	6	4,20 €	1,68 €	
DA110-08-06.500U0-BOW-1	6,5	5,22 €	2,09 €	
DA110-08-06.800U0-BOW-1	6,8	6,61 €	2,64 €	
DA110-08-07.000U0-BOW-1	7	6,25 €	2,5 €	
DA110-08-07.500U0-BOW-1	7,5	6,94 €	2,78 €	
DA110-08-08.000U0-BOW-1	8	6,94 €	2,78 €	
DA110-08-08.500U0-BOW-1	8,5	9,10 €	3,64 €	
DA110-08-09.000U0-BOW-1	9	9,76 €	3,9 €	
DA110-08-09.500U0-BOW-1	9,5	11,19 €	4,48 €	

Bezeichnung	Ø metrisch	Brutto- preis	Aktions- preis*	Stück
DA110-08-10.000U0-BOW-1	10	11,84 €	4,74 €	
DA110-08-10.200U0-BOW-1	10,2	13,07 €	5,23 €	
DA110-08-10.500U0-BOW-1	10,5	13,39 €	5,36 €	
DA110-08-11.000U0-BOW-1	11	15,48 €	6,19 €	
DA110-08-11.500U0-BOW-1	11,5	16,81 €	6,72 €	
DA110-08-12.000U0-BOW-1	12	18,52 €	7,41 €	
DA110-08-12.500U0-BOW-1	12,5	21,04 €	8,42 €	
DA110-08-13.000U0-BOW-1	13	23,03 €	9,21 €	
DA110-08-14.000U0-BOW-1	14	29,70 €	11,88 €	
DA110-08-15.000U0-BOW-1	15,5	37,40 €	14,96 €	
DA110-08-16.000U0-BOW-1	16	40,30 €	16,12 €	

Absender

Firma

Name

Straße / Hausnr.

PLZ / Ort

Dieses Formular nutzen und gleich per E-Mail bestellen!

In Kooperation mit:

Die Aktion ist 8 Wochen gültig bzw. solange der Vorrat reicht. Aktionsware ist vom Umtausch ausgeschlossen.  
\* Kundenvorteil (60 %) bereits berücksichtigt. Abbildungen ähnl., Änderungen vorbehalten. Empfohlener Verkaufspreis.

walter-tools.com

Senden



## HSS-Spiralbohrer DA110 Perform – Sets DA110-SET-1-10.5-WZ90AJ DA110-SET-1-13-WZ90AJ

– Typ N

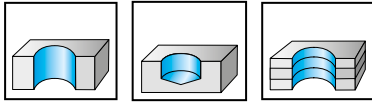

WZ90AJ	P	M	K	N	S	H	O
	●●	●	●●	●	●		●

Bezeichnung	Sätze Ø mm	Inklusive Kernloch- bohrer [mm]	Steigung	Stück im Set	Brutto- preis	Aktions- preis*	Bestell- menge
DA110-SET-1-10.5-BOW	1,0–10,5	3,3 4,2 6,8 10,2	0,5	24	49,60 €	39,68 €	
DA110-SET-1-13-BOW	1,0–13,0		0,5	25	100,00 €	80,00 €	



## HSS-E Spiralbohrer A1244 – Satz Z3515, Z3516

– Typ VA

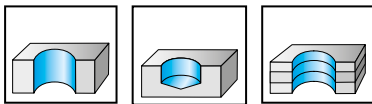

unbeschichtet	P	M	K	N	S	H	O
	●	●●		●	●●		

Bezeichnung	Sätze Ø mm	Inklusive Kernloch- bohrer [mm]	Steigung	Stück im Set	Brutto- preis	Aktions- preis*	Bestell- menge
Z3515-1-10.5-BOW	1,0–10,5	3,3 4,2 6,8 10,2	0,5	24	148,00 €	118,40 €	
Z3516-1-13-BOW	1,0–13,0		0,5	25	258,00 €	206,40 €	



Absender

\_\_\_\_\_

Firma

\_\_\_\_\_

Name

\_\_\_\_\_

Straße / Hausnr.

\_\_\_\_\_

PLZ / Ort

**Dieses Formular nutzen und gleich per E-Mail bestellen!**

In Kooperation mit:

\_\_\_\_\_

Die Aktion ist 8 Wochen gültig bzw. solange der Vorrat reicht. Aktionsware ist vom Umtausch ausgeschlossen.  
\* Kundenvorteil (20 %) bereits berücksichtigt. Abbildungen ähnl., Änderungen vorbehalten. Empfohlener Verkaufspreis.

walter-tools.com

Senden



## HSS-E Spiralbohrer A1222 – Satz Z3518 UFL®

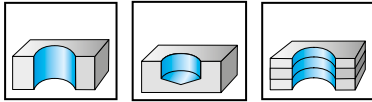

unbeschichtet	P	M	K	N	S	H	O
	●●	●	●●	●			

Bezeichnung	Sätze Ø mm	Inklusive Kernloch- bohrer [mm]	Steigung	Stück im Set	Brutto- preis	Aktions- preis*	Bestell- menge
Z3518-1-10.5-BOW	1,0–10,5	3,3 4,2 6,8 10,2	0,5	24	103,00 €	82,40 €	



## HSS-Spiralbohrer A1211 – Satz Z3213, Z3216

– Typ N

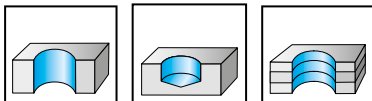

unbeschichtet	P	M	K	N	S	H	O
	●●	●	●●	●	●		●●

Bezeichnung	Sätze Ø mm	Inklusive Kernloch- bohrer [mm]	Steigung	Stück im Set	Brutto- preis	Aktions- preis*	Bestell- menge
Z3213-1-6-BOW	1,0–6,0		0,1	51	72,40 €	57,92 €	
Z3216-6-10-BOW	6,0–10,0		0,1	41	162,00 €	129,60 €	



Absender

Firma

Name

Straße / Hausnr.

PLZ / Ort

Dieses Formular nutzen und gleich per E-Mail bestellen!

In Kooperation mit:

Die Aktion ist 8 Wochen gültig bzw. solange der Vorrat reicht. Aktionsware ist vom Umtausch ausgeschlossen.  
\* Kundenvorteil (20 %) bereits berücksichtigt. Abbildungen ähnl., Änderungen vorbehalten. Empfohlener Verkaufspreis.

walter-tools.com

Senden



## HSS-Spiralbohrer A1211TIN / A1211 – Satz Z3218TIN, Z3218, Z3219TIN, Z3219

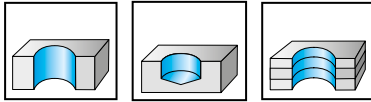

	P	M	K	N	S	H	O
TIN	●●	●	●●	●	●		●
unbeschichtet	●●	●	●●	●	●		●

Bezeichnung	Sätze Ø mm	Inklusive Kernloch- bohrer [mm]	Steigung	Stück im Set	Brutto- preis	Aktions- preis*	Bestell- menge
 Z3218TIN-1-10.5-BOW	1,0–10,5	3,3 4,2 6,8 10,2	0,5	24	132,00 €	105,60 €	
Z3219TIN-1-13-BOW	1,0–13,0		0,5	25	198,00 €	158,4 €	
 Z3218-1-10.5-BOW	1,0–10,5	3,3 4,2 6,8 10,2	0,5	24	61,50 €	49,20 €	
Z3219-1-13-BOW	1,0–13,0		0,5	25	89,50 €	71,60 €	

## HSS-Kegelsenker E6819TIN 90° – Satz Z3711TIN

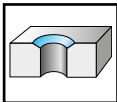

	P	M	K	N	S	H	O
TIN	●●	●●	●●	●●	●		●●

Bezeichnung	Größter Senker-Ø mm	Kleinster Senker-Ø mm	Stück im Set	Brutto- preis	Aktions- preis*	Bestell- menge
 Z3711TIN-6.3-20.5-BOW	6,3 8,3 10,4 12,4 16,5 20,5	1,5 2,0 2,5 2,8 3,2 3,5	6	95,10 €	76,08 €	

Absender

\_\_\_\_\_

Firma

\_\_\_\_\_

Name

\_\_\_\_\_

Straße / Hausnr.

\_\_\_\_\_

PLZ / Ort

Dieses Formular nutzen und gleich per E-Mail bestellen!

In Kooperation mit:

Die Aktion ist 8 Wochen gültig bzw. solange der Vorrat reicht. Aktionsware ist vom Umtausch ausgeschlossen.

\* Kundenvorteil (20 %) bereits berücksichtigt. Abbildungen ähnl., Änderungen vorbehalten. Empfohlener Verkaufspreis.

walter-tools.com

Senden



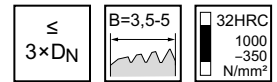
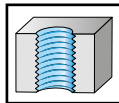
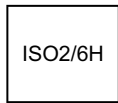
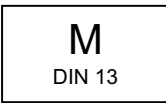

## HSS-E Gewindebohrer-Set 1 TC216 Perform

– Universeller Gewindebohrer-Satz



	P	M	K	N	S	H	O
WY80AA (TiN)	●●	●●	●●	●●			
WY80FC (vap)	●●	●●	●●	●●			



Bezeichnung	D <sub>N</sub>	–	Sorte	Stückzahl	Brutto- preis	Aktions- preis*	Bestell- menge
 TC216-SET1-M3-M12-AA-BOW	M3		WY80AA	7	106,00 €	84,80 €	
	M4						
	M5						
	M6						
	M8						
	M10						
	M12						
 TC216-SET1-M3-M12-FC-BOW	M3		WY80FC	7	85,20 €	68,16 €	
	M4						
	M5						
	M6						
	M8						
	M10						
	M12						

## HSS-E Gewindebohrer-Set 2 TC216 + DA110 Perform

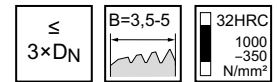
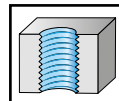
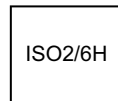
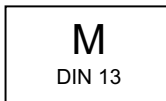
– Universeller Gewindebohrer-Satz  
– inkl. Kernlochbohrer



	P	M	K	N	S	H	O
WY80AA (TiN)	●●	●●	●●	●●			
WY80FC (vap)	●●	●●	●●	●●			

Bezeichnung	D <sub>N</sub>	Inklusive Kernloch- bohrer [mm]	Sorte	Stückzahl	Brutto- preis	Aktions- preis*	Bestell- menge
 TC216-SET2-M3-M12-AA-BOW	M3	2,5	WY80AA	14	133,00 €	106,40 €	
	M4						
	M5						
	M6						
	M8						
	M10						
	M12						
 TC216-SET2-M3-M12-FC-BOW	M3	2,5	WY80FC	14	112,00 €	89,60 €	
	M4						
	M5						
	M6						
	M8						
	M10						
	M12						

Absender

\_\_\_\_\_

Firma

\_\_\_\_\_

Name

\_\_\_\_\_

Straße / Hausnr.

\_\_\_\_\_

PLZ / Ort

Dieses Formular nutzen und gleich per E-Mail bestellen!

In Kooperation mit:

Die Aktion ist 8 Wochen gültig bzw. solange der Vorrat reicht. Aktionsware ist vom Umtausch ausgeschlossen.

\* Kundenvorteil (20 %) bereits berücksichtigt. Abbildungen ähnl., Änderungen vorbehalten. Empfohlener Verkaufspreis.

walter-tools.com

Senden



## HSS-E Gewindebohrer-Set 1 TC115 Perform

– Universeller Gewindebohrer-Satz

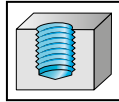
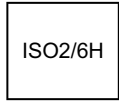
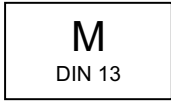
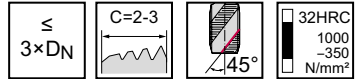

	P	M	K	N	S	H	O
WY80AA (TiN)	●●	●●	●●	●			
WY80FC (vap)	●●	●●	●●	●			



Bezeichnung	Sätze Ø mm	–	Sorte	Stückzahl	Brutto- preis	Aktions- preis*	Bestell- menge
 TC115-SET1-M3-M12-AA-BOW	M3 M4 M5 M6 M8 M10 M12		WY80AA	7	111,00 €	88,80 €	
 TC115-SET1-M3-M12-FC-BOW	M3 M4 M5 M6 M8 M10 M12		WY80FC	7	89,30 €	71,44 €	

## HSS-E Gewindebohrer-Set 2 TC115 + DA110 Perform

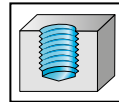
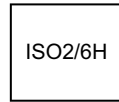
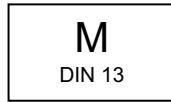
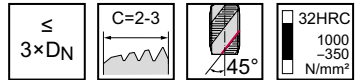
– Universeller Gewindebohrer-Satz  
– inkl. Kernlochbohrer



	P	M	K	N	S	H	O
WY80AA (TiN)	●●	●●	●●	●			
WY80FC (vap)	●●	●●	●●	●			

Bezeichnung	Sätze Ø mm	Inklusive Kernloch- bohrer [mm]	Sorte	Stückzahl	Brutto- preis	Aktions- preis*	Bestell- menge
 TC115-SET2-M3-M12-AA-BOW	M3 M4 M5 M6 M8 M10 M12	2,5 3,3 4,2 5,0 6,8 8,5 10,2	WY80AA	14	138,00 €	110,40 €	
 TC115-SET2-M3-M12-FC-BOW	M3 M4 M5 M6 M8 M10 M12	2,5 3,3 4,2 5,0 6,8 8,5 10,2	WY80FC	14	116,00 €	92,80 €	

Absender

\_\_\_\_\_  
Firma

\_\_\_\_\_  
Name

\_\_\_\_\_  
Straße / Hausnr.

\_\_\_\_\_  
PLZ / Ort

**Dieses Formular nutzen und gleich per E-Mail bestellen!**

\_\_\_\_\_  
In Kooperation mit:

Die Aktion ist 8 Wochen gültig bzw. solange der Vorrat reicht. Aktionsware ist vom Umtausch ausgeschlossen.  
\* Kundenvorteil (20 %) bereits berücksichtigt. Abbildungen ähnl., Änderungen vorbehalten. Empfohlener Verkaufspreis.

**walter-tools.com**

**Senden**

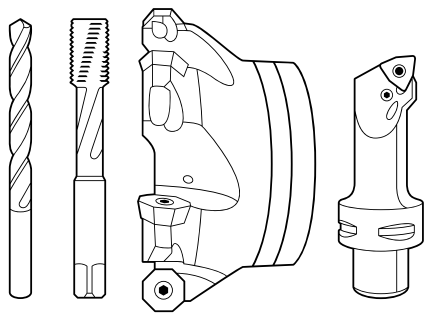

[www.walter-tools.com](http://www.walter-tools.com)